

SPECIFICATIONS

Features

- Work for most 3-wire/ 2-wire dimmer
- Compact size
- Low profile
- Constant Current Output
- Active Power Factor
- Class 2 compliance
- Restart at lowest dimming setting
- 5 Year Warranty

Wiring Diagram

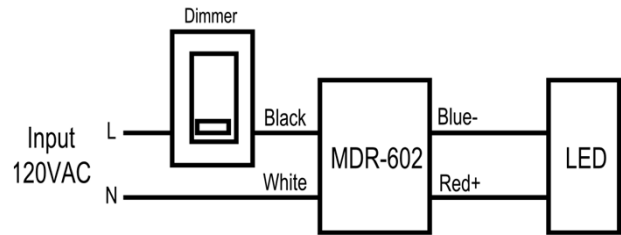

Mechanical and Thermal

Dimensions	L3.937"XW1.654"XH0.997"
Lead Wire Length	6" (Standard)
Max. Case Operation Temp.	80°C

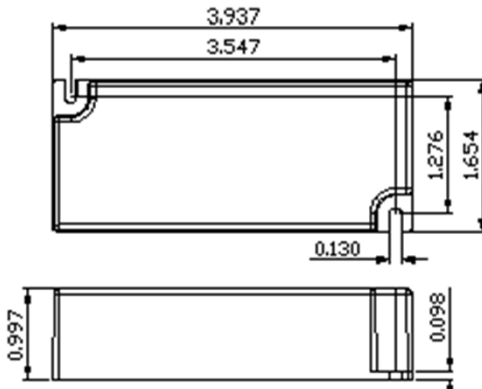

* Dimension in Inch

Protection

- Auto-reset electronic short circuit
- Overload protection
- Thermal protection
- Class 2

Environmental Specifications

- MTBF >100,000 hrs
- RoHS Compliant
- Lead Free SMT process
- Power Factor Correction / Low Load
- FCC Part 15 Class B compliant

Electrical

Maximum Load	10W
Minimum Load	7W
Input Voltage	120V
Max Output Voltage/Current	45VDC/220mA
Power Factor	>0.90
Max. Harmonic Distortion	<20%
Efficiency	80 typ.
No Load Loss	<1 W
TRIAC dimmable (2 wire& 3 wire dimmer)	
(see dimming compatibility)	



Note –

1. UL file No. : E340871



Macron Associate Co. – Power Supply Team

NO.352, Peng-Yi Road, Taiping, Taichung, Taiwan 411

TEL: 886-4-22708357 FAX: 886-4-22767307 Email: macron@macrongroup.com

C1115